

OWNER'S MANUAL
GUIDE D'UTILISATION
MANUAL DE INSTRUCCIONES

 **SANSUI®**

46" CLASS WIDE LED-LCD TV
TÉLÉVISEUR DEL GRAND ÉCRAN CATÉGORIE 46 PO
TELEVISOR LCD PANORÁMICO DE 46"

SLED4650

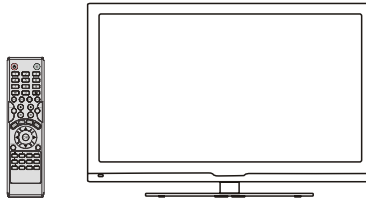

**ATTENTION
ATTENTION
ATENCIÓN**

If you purchase a universal remote control from your local retailer, please contact the remote manufacturer for the required programming code.
Si vous utilisez avec cet appareil une télécommande universelle (autre que celle vendue avec ce téléviseur), consultez la documentation accompagnant la télécommande universelle afin de connaître le code numérique correspondant au téléviseur.
Si usted ha comprado un control remoto universal, por favor comunicarse con el fabricante para el código de programación requerido.

**AIR/CABLE MODE SELECTION
SÉLECTION DU MODE AIR/CABLE
SELECCION DE MODO DE ANTENA/CABLE**

When shipped from the factory, the Signal Type option is set to the "Cable" (Cable Television) mode.
If not using Cable TV, set this menu option to the "Air" position.
Lorsque l'appareil sort de l'usine, l'option Signal Type est en mode « Cable » (câblodistribution). Si vous n'utilisez pas la câblodistribution, sélectionnez l'option « Air ».
Al salir la unidad de fábrica, la opción Tipo de Señal se ajusta al modo de "Cable" (Televisión por cable). Si no utiliza CATV, ajuste esta opción de menú al modo de "Air".

**IF CONTACT WITH CUSTOMER SERVICE IS REQUIRED
PLEASE HAVE THE MODEL NUMBER READY PRIOR TO THE CALL.
SI VOUS DEVEZ COMMUNIQUER AVEC LE SERVICE CLIENTÈLE PRENEZ NOTE!
DU NUMÉRO DE MODÈLE AVANT D'APPELER.
SI REQUIERE CONTACTAR SERVICIO AL CLIENTE POR FAVOR TENGA EL NÚMERO DE MODELO LISTO ANTES LLAMAR
CUSTOMER SERVICE – 1-800-289-0980
SERVICE/SERVICE CLIENTÈLE: 1-800-289-0980
SERVICIO AL CLIENTE – 1-800-289-0980**

**ORION WEBSITE
SITE WEB ORION
SITIO WEB DE ORION**

FOR INFORMATION ON OUR OTHER PRODUCTS, TO ORDER ACCESSORIES ONLINE, OR FOR RECYCLE INFORMATION, PLEASE VISIT OUR WEBSITE AT:
POUR OBTENIR DES INFORMATIONS SUR NOS AUTRES PRODUITS ET LE RECYCLAGE, VÉUILLEZ VISITER NOTRE SITE WEB:
PARA INFORMACIÓN SOBRE OTROS PRODUCTOS E INFORMACIÓN SOBRE RECICLAJE,
POR FAVOR VISITE NUESTRO SITIO WEB EN

www.orionsalesinc.com

Before operating the unit, please read this manual thoroughly.
Avant de faire fonctionner l'appareil, veuillez lire le présent guide attentivement.
Antes de usar la unidad, lea detenidamente este manual de instrucciones.

ENGLISH
FRANÇAIS
ESPAÑOL

ENGLISH

	CAUTION RISK OF ELECTRIC SHOCK DO NOT OPEN	
CAUTION: TO REDUCE THE RISK OF ELECTRIC SHOCK, DO NOT REMOVE COVER (OR BACK). NO USER-SERVICEABLE PARTS INSIDE. REFER SERVICING TO QUALIFIED SERVICE PERSONNEL.		



The lightning flash with arrowhead symbol, within an equilateral triangle is intended to alert the user to the presence of uninsulated dangerous voltage within the product's enclosure that may be of sufficient magnitude to constitute a risk of electric shock.



The exclamation point within an equilateral triangle is intended to alert the user to the presence of important operating and maintenance (servicing) instructions in the literature accompanying the appliance.

WARNING: TO PREVENT FIRE OR SHOCK HAZARD, DO NOT EXPOSE THIS APPLIANCE TO RAIN OR MOISTURE.
TO PREVENT THE SPREAD OF FIRE, KEEP CANDLES OR OPEN FLAMES AWAY FROM THIS PRODUCT AT TIMES.

CAUTION: TO PREVENT ELECTRIC SHOCK. DO NOT USE THIS POLARIZED PLUG WITH AN EXTENSION CORD, RECEPTACLE OR OTHER OUTLET UNLESS THE BLADES CAN BE FULLY INSERTED TO PREVENT BLADE EXPOSURE.

WARNING: This equipment has been tested and found to comply with the limits for a Class B digital device, pursuant to Part 15 of the FCC Rules. These limits are designed to provide reasonable protection against harmful interference in a residential installation. This equipment generates, uses and can radiate radio frequency energy and, if not installed and used in accordance with the instructions, may cause harmful interference to radio communications. However, there is no guarantee that interference will not occur in a particular installation. If this equipment does cause harmful interference to radio or television reception, which can be determined by turning the equipment off and on, the user is encouraged to try to correct the interference by one or more of the following measures:

- Reorient or relocate the receiving antenna.
- Increase the separation between the equipment and receiver.
- Connect the equipment into an outlet on a circuit different from that to which the receiver is connected.
- Consult the dealer or an experienced radio/TV technician for help.

CAUTION: Changes or modifications not expressly approved by the party responsible for compliance with the FCC Rules could void the user's authority to operate this equipment.

The lamp(s) within this product contain mercury. Disposal should be in compliance with local, state or federal laws.

Location of the required Marking

The rating sheet and the safety caution are on the rear of the unit.



Record the model number and serial number.

Model number _____ Serial number _____

IMPORTANT SAFETY INSTRUCTIONS

- 1) Read these instructions.
- 2) Keep these instructions.
- 3) Heed all warnings.
- 4) Follow all instructions.
- 5) Do not use this apparatus near water.
- 6) Clean only with dry cloth.
- 7) Do not block any ventilation openings. Install in accordance with the manufacturer's instructions.
- 8) Do not install near any heat sources such as radiators, heat registers, stoves, or other apparatus (including amplifiers) that produce heat.
- 9) Do not defeat the safety purpose of the polarized or grounding-type plug. A polarized plug has two blades with one wider than the other. A grounding type plug has two blades and a third grounding prong. The wide blade or the third prong are provided for your safety. If the provided plug does not fit into your outlet, consult an electrician for replacement of the obsolete outlet.
- 10) Protect the power cord from being walked on or pinched particularly at plugs, convenience receptacles, and the point where they exit from the apparatus.
- 11) Only use attachments/accessories specified by the manufacturer.
- 12) Use only with cart, stand, tripod, bracket, or table specified by the manufacturer, or sold with the apparatus. When a cart is used, use caution when moving the cart/apparatus combination to avoid injury from tip-over.
- 13) Unplug this apparatus during lightning storms or when unused for long periods of time.
- 14) Refer all servicing to qualified service personnel. Servicing is required when the apparatus has been damaged in any way, such as power-supply cord or plug is damaged, liquid has been spilled or objects have fallen into the apparatus, the apparatus has been exposed to rain or moisture, does not operate normally, or has been dropped.
- 15) Apparatus should not be exposed to dripping or splashing, and objects filled with liquids, such as vases, should not be placed on the apparatus.
- 16) An outside antenna system should not be located in the vicinity of overhead power lines or other electric light or power circuits, or where it can fall into such power lines or circuits. When installing an outside antenna system, extreme care should be taken to keep from touching such power lines or circuits, as contact with them might be fatal.
- 17) Do not overload wall outlets and extension cords, as this can result in a risk of fire or electric shock.
- 18) Do not push objects through any openings in this unit, as they may touch dangerous voltage points or short out parts that could result in fire or electric shock. Never spill or spray any type of liquid into the unit.



- 19) If an outside antenna or cable system is connected to the unit, be sure the antenna or cable system is grounded to provide some protection against voltage surges and built-up static charges, Section 810 of the National Electrical Code, ANSI/NFPA 70, provides information with respect to proper grounding of the mast and supporting structure, grounding of the lead-in wire to an antenna discharge unit, size of grounding conductors, location of antenna discharge unit, connection to grounding electrodes, and requirements for the grounding electrode.

EXAMPLE OF ANTENNA GROUNDING AS PER THE NATIONAL ELECTRICAL CODE

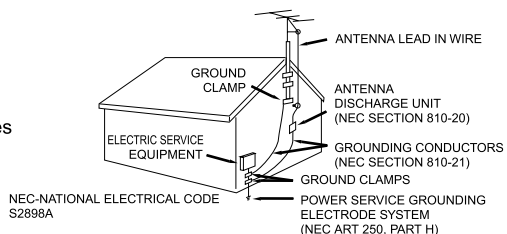

IMPORTANT SAFETY INSTRUCTIONS

- 20) When replacement parts are required, be sure the service technician uses replacement parts specified by the manufacturer or those that have the same characteristics as the original part. Unauthorized substitutions may result in fire, electric shock or other hazards.
- 21) Upon completion of any service or repairs to this unit, ask the service technician to perform safety checks to determine that the unit is in proper operating condition.
- 22) When you connect the product to other equipment, turn off the power and unplug all of the equipment from the wall outlet. Failure to do so may cause an electric shock and serious personal injury. Read the owner's manual of the other equipment carefully and follow the instructions when making any connections.
- 23) Sudden high volume sound may cause hearing or speaker damage. When you use headphones, (if the unit is equipped with a headphone jack) keep the volume at a moderate level. If you use headphones continuously with high volume sound, it may cause hearing damage.
- 24) Do not allow the product to output distorted sound for an extended period of time. It may cause speaker overheating and fire.
- 25) This reminder is provided to call the cable TV system installer's attention to Article 820-40 of the NEC that provides guidelines for proper grounding and, in particular, specifies that the cable ground shall be connected to the grounding system of the building, as close to the point of cable entry as practical.
- 26) The socket-outlet must be installed near the unit and easily accessible.

CHILD SAFETY:

It Makes A Difference How and Where You Use Your Flat Panel Display

Congratulations on your purchase! As you enjoy your new product, please keep these safety tips in mind:

THE ISSUE

The home theater entertainment experience is a growing trend and larger flat panel displays are popular purchases. However, flat panel displays are not always supported on the proper stands or installed according to the manufacturer's recommendations.

Flat panel displays that are inappropriately situated on dressers, bookcases, shelves, desks, speakers, chests or carts may fall over and cause injury.

THIS MANUFACTURER CARES!

The consumer electronics industry is committed to making home entertainment enjoyable and safe.

TUNE INTO SAFETY

One size does NOT fit all. Follow the manufacturer's recommendations for the safe installation and use of your flat panel display.

Carefully read and understand all enclosed instructions for proper use of this product.

Don't allow children to climb on or play with furniture and television sets.

Don't place flat panel displays on furniture that can easily be used as steps, such as a chest of drawers.

Remember that children can become excited while watching a program, especially on a "larger than life" flat panel display. Care should be taken to place or install the display where it cannot be pushed, pulled over, or knocked down.

Care should be taken to route all cords and cables connected to the flat panel display so that they cannot be pulled or grabbed by curious children.

WALL MOUNTING: IF YOU DECIDE TO WALL MOUNT YOUR FLAT PANEL DISPLAY, ALWAYS:

Use a mount that has been recommended by the display manufacturer and/or listed by an independent laboratory (such as UL, CSA, ETL).

Follow all instructions supplied by the display and wall mount manufacturers.

If you have any doubts about your ability to safely install your flat panel display, contact your retailer about professional installation.

Make sure that the wall where you are mounting the display is appropriate to support the weight of the unit/product and wall mount. If you are unsure, contact a professional installer.

A minimum of two people are required for installation. Flat panel displays can be heavy.

IMPORTANT SAFETY INSTRUCTIONS

CONDENSATION

Moisture will form in the operating section of the unit if the unit is brought from cool surroundings into a warm room or if the temperature of the room rises suddenly. When this happens, unit's performance will be impaired. To prevent this, let the unit stand in its new surroundings for about an hour before switching it on, or make sure that the room temperature rises gradually. Condensation may also form during the summer if the unit is exposed to the breeze from an air conditioner. In such cases, change the location of the unit.

HOW TO HANDLE THE LCD PANEL

- Do not press hard or jolt the LCD panel. It may cause the LCD panel glass to break and injury may occur.
 - If the LCD panel is broken, make absolutely sure that you do not touch the liquid in the panel. This may cause skin inflammation.
- If the liquid gets in your mouth, immediately gargle and consult with your doctor. Also, if the liquid gets in your eyes or touches your skin, consult with your doctor after rinsing for at least 15 minutes or longer in clean water.

Possible Adverse Effects on LCD Panel: If a fixed (non-moving) pattern remains on the LCD Panel for long periods of time, the image can become permanently engrained in the LCD Panel and cause subtle but permanent ghost images. This type of damage is NOT COVERED BY YOUR WARRANTY. Never leave your LCD Panel on for long periods of time while it is displaying the following formats or images:

- Fixed Images, such as stock tickers, video game patterns, TV station logos, and websites.
- Special Formats that do not use the entire screen. For example, viewing letterbox style (16:9) media on a normal (4:3) display (black bars at top and bottom of screen); or viewing normal style (4:3) media on a widescreen (16:9) display (black bars on left and right sides of screen).

The following symptoms are not signs of malfunction but technical limitation. Therefore we disclaim any responsibility for these symptoms.

- LCD Panels are manufactured using an extremely high level of precision technology, however sometimes parts of the screen may be missing picture elements or have luminous spots. This is not a sign of a malfunction.
- Do not install the LCD Panel near electronic equipment that produces electromagnetic waves. Some equipment placed too near this unit may cause interference.
- Effect on infrared devices – There may be interference while using infrared devices such as infrared cordless headphones.

SAFETY PRECAUTIONS

The unit emits heat when in operation. Do not place any covers or blankets on the unit, this may cause overheating. Do not block ventilation holes, or set up near radiators. Do not place in direct sunshine. When placing on a shelf leave 10 cm (4 inches) free space around the entire unit.

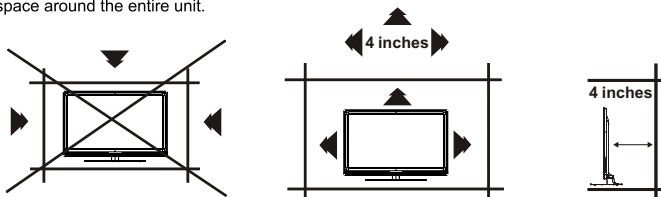

Notes when mounting the LCD TV on a wall

- If the unit is to be mounted on the wall, contact the retailer where you purchased the LCD TV for advice, and have the equipment professionally installed. Incomplete or improper installation may cause injury to you, and/or damage to the LCD TV.
- Bracket holes: To attach a wall mounting bracket (not supplied) attach where indicated in the drawing right.
- This manufacturer recommends professional installation.
- Utilize an appropriate bracket and fasteners, sufficient to accommodate the size and weight of the unit.
- Assure the wall to which the unit is to be mounted will safely support the size and weight of the unit, using the bracket and fasteners you have selected.
- Keep cords and cables connected to this flat panel display out of reach of children.
- To hang the television on a wall, remove these screws and then remove a stand. Before performing work spread cushioning over the base area to lay the TV on.

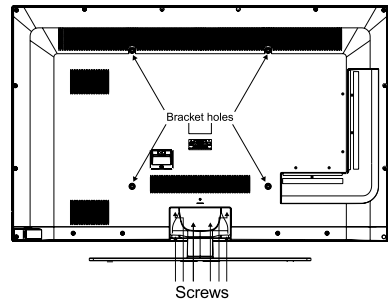

Contents

Before using your unit

IMPORTANT SAFETY INSTRUCTIONS.....	3
SAFETY PRECAUTIONS.....	5
Contents.....	6
How to install the stand	7
How to remove the stand	7
Antenna Connection	8
Cable TV Connection	8
Feature.....	9
Power Source.....	9
Parts and Functions	10
Remote Control	11
Connection to other equipment	13

TV operation

Setup Wizard.....	15
Operating the Menu	16
Picture Menu	17
Audio Menu.....	18
Time Menu.....	18
Setup Menu.....	19
Lock Menu.....	21
Channel Menu	23

Additional information

Reception disturbances	25
Troubleshooting	26
Specifications	27
limited WARRANTY	28

How to attach the stand

NOTE:

- Unplug the AC cord from the AC outlet.
- Ensure that unpacking and transfer of the unit is carried out by two or more people.
- Before beginning this process, assure that the TV is laid on a clean, safe, and cushioned surface to avoid any damage to the unit.
- Do not touch or press the TV-screen, glass might break under pressure.

Place the TV on its front onto a table.

Align the Frame Stand with the TV as below and insert securely.

Align the stand's bottom-plate (supplied) as seen here.

It will fit in only one direction.

Hold the unit and attach the stand slowly, as shown in Figure 1.

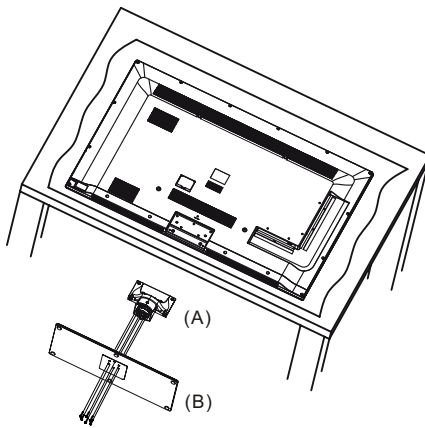

Figure 1

Figure 2

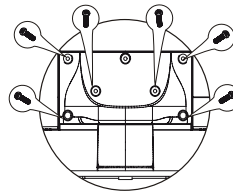
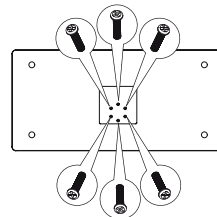

Figure 3



Finally secure the bottom-plate with 6 screws (supplied) as indicated by the arrows in Figure 2 and Figure 3.

- Be sure to follow the instructions. Insufficient tightening or incorrect installation of the stand will not support your unit correctly, and could result in damage or injury from tip-over.

How to remove the stand

When you transport this product, remove the stand and pack flat at against the back of the unit in the carton. To remove the stand, perform these steps in reverse order.

For wall mounting, the base must be removed. To disconnect the base/stand remove the 7 screws from the back (see page 5).

Antenna connections

If you are using an indoor or outdoor antenna, follow the instructions below that correspond to your antenna system. If you are using a Cable TV service, see "Cable TV connections".

Combination VHF/UHF Antenna (Single 75 ohm cable)

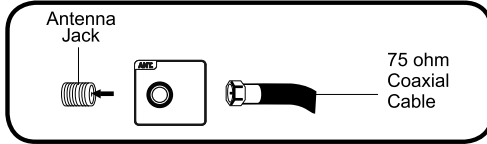

Connect the 75 ohm cable from the combination VHF/UHF antenna to the antenna jack.

Cable TV connections

This TV has an extended tuning range and can tune most cable channels without using a Cable TV Converter box. Some cable companies offer "premium pay channels" where the signal is scrambled. Descrambling these signals for normal viewing requires the use of a descrambler device which is generally provided by the Cable TV company.

For subscribers to basic Cable TV service

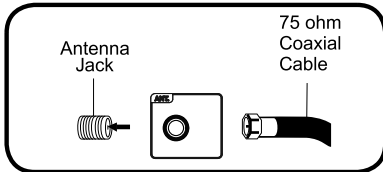

For basic Cable TV service not requiring a Converter/Descrambler box, connect the 75 ohm Coaxial Cable directly to the Antenna Jack on the back of the TV.

For subscribers to scrambled Cable TV service

If you subscribe to a Cable TV service which requires the use of a Converter/Descrambler box, connect the incoming 75 ohm Coaxial Cable to the Converter/Descrambler box. Using another 75 ohm Coaxial Cable, connect the output jack of the Converter/Descrambler box to the Antenna Jack on the TV. Follow the connections shown below. Set the TV to the output channel of the Converter/Descrambler box (usually channel 3 or 4) and use the Converter/Descrambler box to select channels.

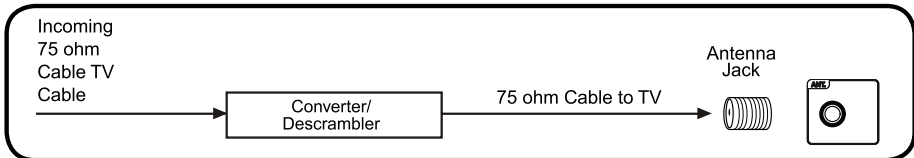

For subscribers to unscrambled Cable TV service with scrambled premium channels

If you subscribe to a Cable TV service in which basic channels are unscrambled and premium channels require the use of a Converter/Descrambler box, you may wish to use a signal Splitter and an A/B Switch box (available from the Cable TV company or an electronics supply store). Follow the connections shown below. With the switch in the "B" position, you can directly tune any unscrambled channels on your TV. With the switch in the "A" position, tune your TV to the output of the Converter/Descrambler box (usually channel 3 or 4) and use the Converter/Descrambler box to tune scrambled channels.

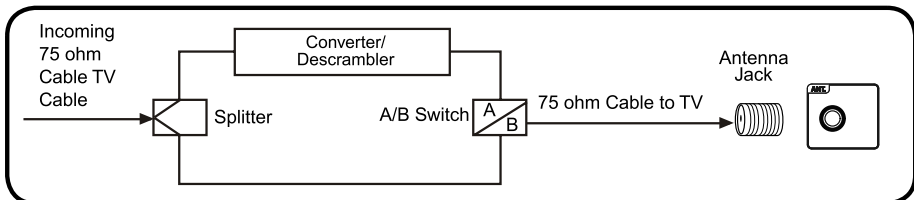

Features

- **LED Backlight System** – It realize thin profile, low power consumption, eco-friendly Hg-less design and high contrast picture.
- **Integrated Digital Tuner** – You can view digital broadcasts without using a Digital TV Set-Top Box.
- **Closed Caption Decoder With Full Text Mode** – Displays text captions or full screen text on the screen for hearing impaired viewers.
- **Picture Adjustments Using The Remote Control** – The On-Screen display allows precise remote control adjustment of BRIGHTNESS, CONTRAST, COLOR, TINT and SHARPNESS.
- **Programmable TV Sleep Timer** – Operable from the remote control, the LCD TV can be programmed for up to 120 minutes to turn off automatically.
- **V-Chip** – The V-Chip function can read the rating of a broadcast program or movie content if the program is encoded with this information. V-Chip will allow you to set a restriction level.
- **Digital Audio Jack (Coaxial)** – When a component with a built-in Dolby Digital decoder is connected, Dolby Digital sound can produce the effect of being in a movie theater or a concert hall.
- **HDMI/Component Video Jacks** – A VCR, DVD player, satellite receiver or other audio/video component can be connected to this unit.
- **On Screen 3 Language Display** – You can select one of 3 languages, English, French or Spanish for on-screen programming.

* Manufactured under license from Dolby Laboratories. Dolby and the double-D symbol are trademarks of Dolby Laboratories.
 * HDMI, the HDMI Logo, and High-Definition Multimedia Interface are trademarks or registered trademarks of HDMI Licensing LLC in the United States and other countries.

Power source

TO USE AC POWER

Connect the AC cord into an AC outlet.

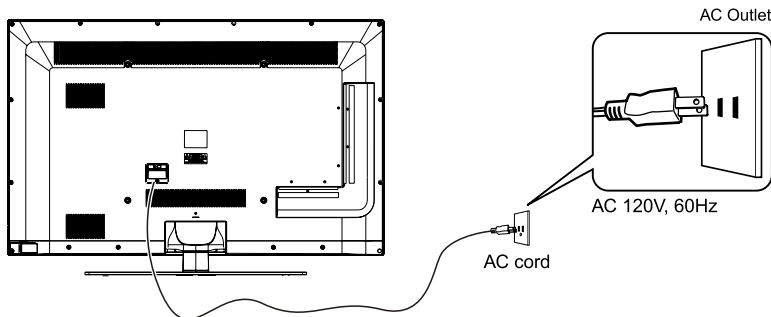

NOTE:

- Please make sure to insert the cord securely the wall outlet.
- The AC cord has a polarized type AC line plug. If the supplied AC cord does not match you AC outlet, contact a qualified electrician, do not defeat the purpose of a grounding plug.

WARNING:

- DO NOT CONNECT THIS UNIT TO THE POWER USING ANY DEVICE OTHER THAN THE SUPPLIED AC CORD. THIS COULD CAUSE FIRE, ELECTRICAL SHOCK, OR DAMAGE.

CAUTION:

- WHEN THIS UNIT IS NOT USED FOR A LONG TIME, (E.G., AWAY ON A TRIP) IN THE INTEREST OF SAFETY, BE SURE TO UNPLUG IT FROM THE AC OUTLET.
- DO NOT PLUG/UNPLUG THE AC CORD WHEN YOUR HANDS ARE WET. THIS MAY CAUSE ELECTRICAL SHOCK.
- IF YOU NEED TO REPLACE THE SUPPLIED AC ADAPTER OR AC CORD, THE SPECIFIED ONE IS RECOMMENDED. CONTACT CUSTOMER SERVICE AT 1-800-289-0980

Parts and Functions

Front View

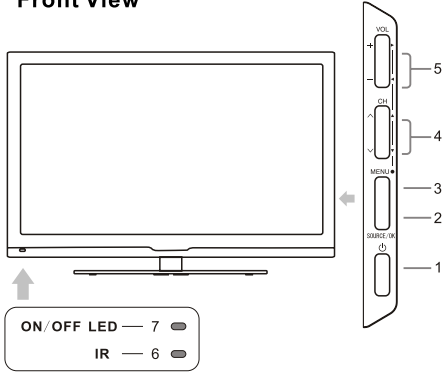

1. Press “**⏻**” button to turn the TV on or off.
2. Press “**SOURCE**” to select the input source.
3. Press “**MENU**” to bring up the main menu on the screen.
4. Press “**CH[^]**” or “**CH^v**” to scan through channels.
5. Press “**VOL+**” or “**VOL-**” to increase or decrease the volume.
6. Remote Sensor: infrared sensor for the remote control.
7. Power Indicator: Blue when TV is powered on. Red when TV is powered off. No color when power switch is turned off.

Back View and Control Connections

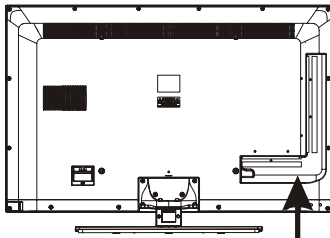

1. **USB**: Service Port for Factory Use Only.
2. **HDMI1/HDMI2/HDMI3**: Connect the HDMI connection from your external HDMI capable device.
3. **PC MONITOR IN**: Connect the PC-RGB output jack of PC.
4. **COMPONENT**: Connect the COMPONENT connection from your external COMPONENT capable device.
L/R(Shared audio with AV IN): For COMPONENT audio.
5. **VIDEO**: The VIDEO input from your external device.
6. **ANT**: Connect the antenna.
7. **DIGITAL AUDIO OUT**: Connect the COAXIAL receiver.
8. **PC AUDIO IN**: Connect the Audio output jack of PC.
9. : Connect to a headphone.

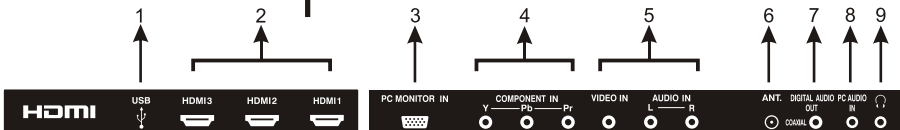

Remote Control



POWER
Turn the LED-LCD TV ON or OFF.

MUTE
Press to mute the sound. Press again or press VOL+ to un-mute the TV.

NUMBER BUTTONS
Press 0-9 to directly change the TV channel.

Press this button to enter a program number for multiple program channel such as 2-1, etc.

RETURN
Return to the previous channel viewed.

P.MODE
Select the picture mode.

S.MODE
Select the sound mode.

MTS
Press to adjust between available audio channels.

SLEEP
Set the sleep timer.

SOURCE
Press SOURCE to display the OSD input source, press ▲▼ to select an input source, and then press OK to confirm.

VOL+/VOL-
Press to increase / decrease the sound level.

CH+/CH-
Press to scan through channels.

INFO
Display information about the current channel. Press again to release it.

FREEZE
Press to freeze the current screen, press again to release.

CH.LIST
Press to display the TV program list.

AUTO
Auto adjust (only use in the PC source).

ASPECT
Press to select Aspect Ratio.

THUMBSTICK(▲/▼/◀/▶/OK)
Allows you to navigate the on-screen menus and adjust the system settings to your preference.

MENU
Brings up the main TV menu to the screen.

EXIT
Exit the main TV menu.

||
Press to pause, and again to return normal play.

■
Press to stop playback and clear the memory, press || button to resume play

ADD/ERASE
Add or delete favorite channels.

FAV
Press to display the TV favorite program list.

◀
Press to play the previous screen.

◀◀
Press the button for quick rewind search.

REPEAT
Press to select the repeat mode when playing music the USB source.

EPG
Electronic Program Guide function.

▶▶
Press to play the next screen.

▶
Press for quick forward search.

CC
Press to display the Closed Caption Mode: On, Off and CC on Mute.

V-CHIP
Setting up parental list.

1. Open the cover.
2. Use AAA size batteries. When inserting the batteries, make sure correct polarities "+" and "-" marks on the batteries line up correctly with compartment markings.
3. Replace the battery cover.

To prevent battery leakage which may result in bodily injury or damage to the remote:

1. Install all batteries correctly, and as marked on the remote control.
2. Do not mix batteries: (old, new, carbon, alkaline, etc)
Remove batteries when the remote is not used for a long period of time.

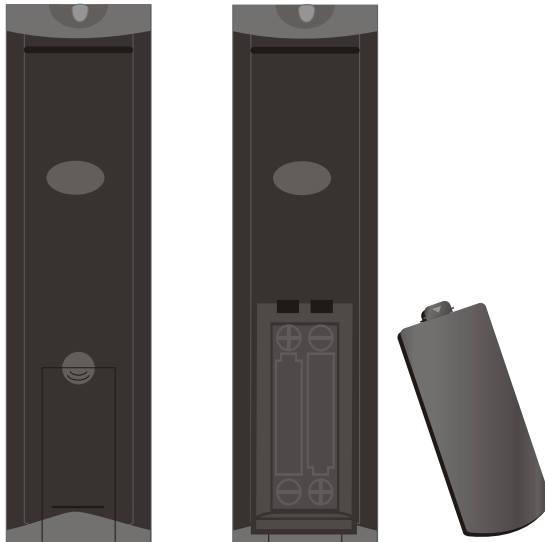

Connection to other equipment

Video Connection

Connect the VIDEO and AUDIO output jack of the DVD or VCR to the VIDEO IN jacks on the unit using the RCA cable. Match the jack colors: Video is yellow, Audio left is white, and Audio right is red. Select the AV input source using the SOURCE button on the remote control.



TV Back

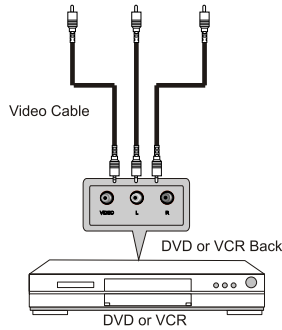

Component Connection

Connect the COMPONENT output of the DVD or VCR to the COMPONENT input on the unit. The picture quality is improved; compared to connecting a regular VCR to the video input. Connect the Audio output of the DVD or VCR to the Audio input jacks on the unit using the RCA cable.

Match the jacks colors :Y is green,Pb is blue,Pr is red,Audio left is white and Audio right in red.

Select component input source using the SOURCE button on the remote control.



TV Back

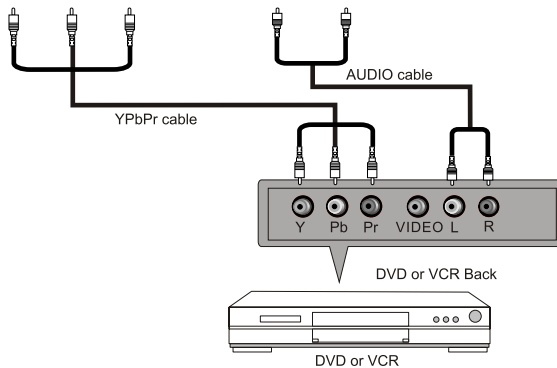

Connection to other equipment

(Continued)

PC in Connection

Connect the RGB output of the PC to the PC MONITOR IN jack on the unit. Connect the AUDIO output of The PC to the PC AUDIO jack on the unit. Select the RGB input source with using SOURCE button on the remote control.

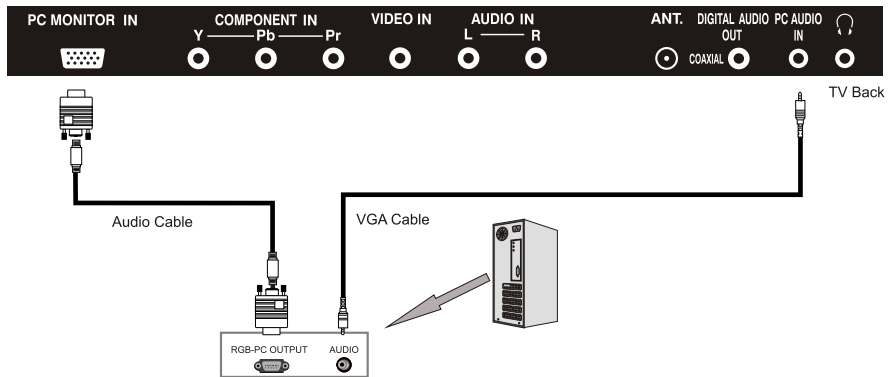

HDMI Connection

HDMI plug which replaces the HDMI connection allows transfer of all audio/video/control signals through one cable only. These signals are transferred in digital.

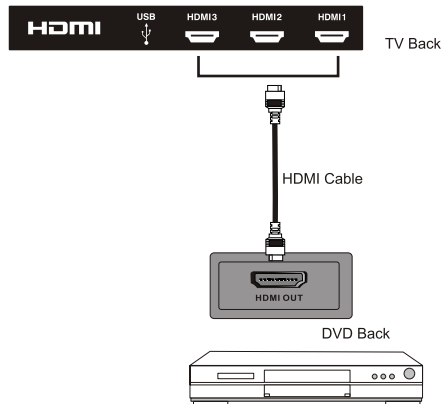

Setup Wizard

SETUP WIZARD

If you are turning on your LED-LCD TV for the first time, you will see the following menu below. Please select Home Mode or Standard Mode to continue.

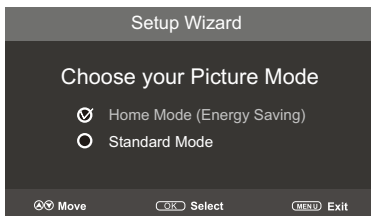

Home Mode (Energy Saving): Select Home Mode to maximize energy efficiency. Please note if you select Home Mode the picture will be darker. This mode meets the requirements of Energy Star[®] qualification.
Standard Mode: Select Standard Mode if you would like your picture to be brighter. At times this mode may use more energy to operate the Volume/Sound mode and the Picture Mode. In this setting, the power consumption may possibly exceed the limited requirement of the Energy Star[®] qualification.

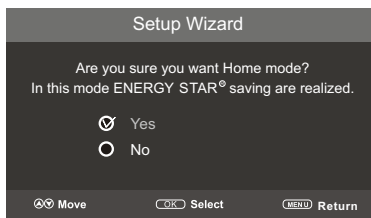

Press Yes to confirm.

Note: If you want change the modes between Home Mode(Energy Saving) and Standard Mode, you can change the setting in the Setup Menu under **TV Location**.

ENERGY STAR[®] is a set of power-saving guidelines issued by the U.S. Environmental Protection Agency(EPA).
ENERGY STAR[®] is a joint program of the U.S. Environmental Protection Agency and the U.S. Department of Energy helping us all save money and protect the environment through energy efficient products and practices.

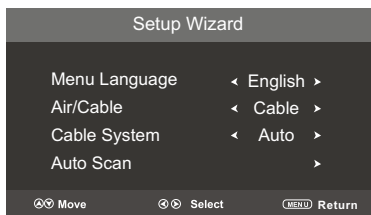

Operating the Menu

1. Press the **POWER** button to turn the LED-LCD TV on.
2. Press the **MENU** button on the remote control, the on-screen menu will appear on the screen.
3. Use the **◀** and **▶** buttons to select your main menu option.

PICTURE MENU:

Allows you to make adjustments to your picture settings.(select TV source for example)

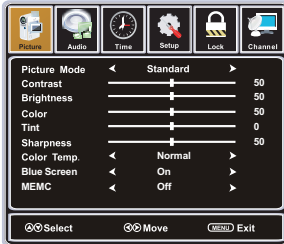

AUDIO MENU:

Allows you to customize the audio options and effects.(select TV source for example)

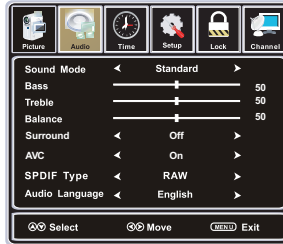

TIME MENU:

Allows you to set up a variety of timer options. (Select TV source for example)

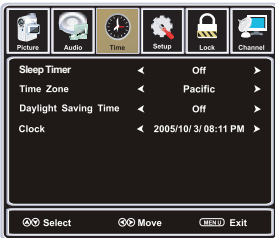

SETUP MENU:

Allows you to set up a variety of setup options. (Select TV source for example)

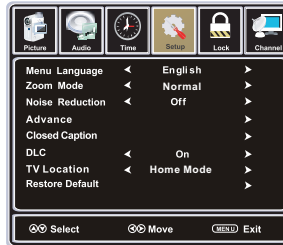

LOCK MENU:

Allows you to set up a variety of lock options. (Select TV source for example)

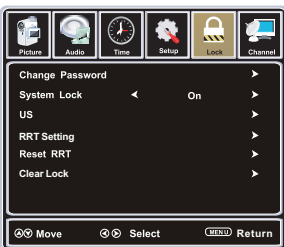

CHANNEL MENU:

Allows you to search channels and set up a variety of channel options. (Select TV source for example)

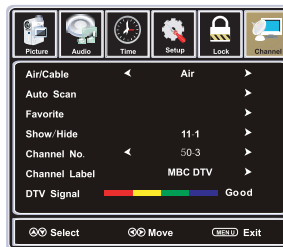

4. Use the ▲ / ▼ buttons to select an option of the sub-menu, and press the ► button. While in adjustment mode, use the ◀ / ▶ button to change the value of the item.
5. Press the MENU button to exit the menu.

Note:

You must input the necessary signal to activate menu options.

1. Press the ⏻ POWER button to turn the LED-LCD TV on.
2. Press the MENU button on the remote control, the on-screen menu will appear on the screen.
3. Use the ◀ / ▶ buttons to select your main menu option.

Picture Menu

Select TV source for example.

1. Press the MENU button on the remote control to display the Main menu, and use the ◀ / ▶ buttons to select the Picture.
2. Use the ▲ / ▼ buttons to highlight an individual Picture option, use the ◀ / ▶ buttons to change the setting, and press the MENU to exit menu.

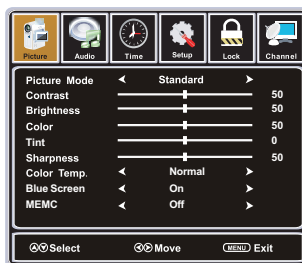

The Picture menu includes the following options :

Picture Mode

Cycles among picture display modes: Standard, Dynamic, Movie, User.

Contrast

Controls the difference between the brightest and darkest regions of the picture.

Brightness

Controls the overall brightness of the picture

Color

Controls the color.

Tint

Controls the tint of the picture.

Sharpness

Increase this setting to see crisp edges in the picture; decrease it for soft edges .

Color Temp.

Cycles among color temp: Normal, Warm, Cool.

Blue Screen

Allows you to select between: On and Off

MEMC (motion enhancement motion control)

Control the MEMC of the picture: Off/Low/Normal/Strong/Demo.

Audio Menu

Select TV source for example.

1. Press the MENU button on the remote control to display the Main menu, and use the ◀/▶ buttons to select AUDIO.
2. Use the ▲/▼ buttons to highlight an individual Audio option, use the ◀/▶ buttons to change the setting, and press the MENU to exit menu.

The Audio menu includes the following options :

Sound Mode

Allows you to select among: User, Standard, Music, Movie.

Bass

Controls the relative intensity of lower pitched sounds.

Treble

Controls the relative intensity of higher pitched sounds

Balance

To adjust the balance of the left and right sound track, or turn off the volume of the left and right sound track.

Surround

Allows you to select between: On and Off

AVC(Auto Volume Control)

Allows you to select auto volume control On or Off, this function allows the volume to be controlled automatically.

SPDIF Type

Allows you to select between: PCM and RAW.

Audio Language

Allows you to select audio languages among: English, Français and Español.

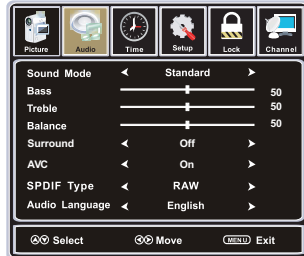

Time Menu

Select TV source for example.

1. Press the MENU button on the remote control to display the Main menu, and use the ◀/▶ buttons to select the Time.
2. Use the ▲/▼ buttons to highlight an individual Time option, use the ◀/▶ buttons to change the setting, and press the MENU button to exit.

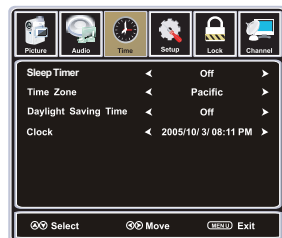

Time Menu

(Continued)

The Time menu includes the following options :

Sleep Timer

Allows you to set up the sleep timer among: 5Min, 10Min, 15Min, 30Min, 45Min, 60Min, 90Min, 120Min, 180Min, 240Min and Off.

Time Zone

Allows you to set up the time zone among: Pacific, Alaska, Hawaii, Eastern, Central and Mountain.

Daylight Saving Time

Allows you to setup the daylight saving between On or Off.

Setup Menu

Select TV source for example.

1. Press the MENU button on the remote control to display the Main menu, and use the ◀/▶ button to select Setup.
2. Use the ▲/▼ buttons to highlight an individual Setup option, use the ◀/▶ buttons to change the setting, and press the MENU button to exit.

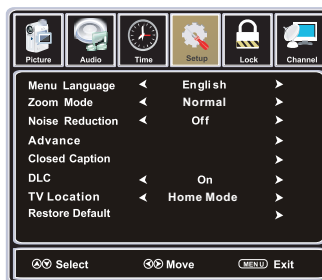

The Setup menu includes the following options:

Menu Language

Allows you to select menu language among: English, Français and Español.

Zoom Mode

Allows you to select the zoom mode among: Normal, Wide, Zoom, Cinema.

Noise Reduction

Allows you to select the noise reduction mode among: Strong, Off, Weak, Middle.

Advance (In VGAMode only)

Input PC signal first, then press SOURCE to select VGA mode, press ▶ button to confirm.

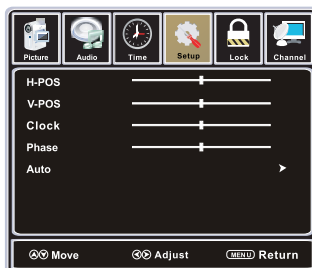

H-POS	Allow you to use ◀/▶ button to adjust the H Position.
V-POS	Allow you to use ◀/▶ button to adjust the V Position.
Clock	Allow you to prolong the image.
Phase	Allow you to adjust the definition.
Auto	Select "Auto" and press ▶, the unit will automatically adjust all items to achieve a best effect.

Setup Menu

(Continued)

Closed Caption

Use ▼ button to highlight the Closed Caption item, then press ► button to enter into the following menu.

CC Mode

Allows you to select the CC Mode among: On, Off and CC on Mute.

Basic Selection

Allows you to select the basic selection among: CC1, CC2, CC3, CC4, Text1, Text2, Text3 and Text4.

Advanced Selection

Allows you to select the advanced selection among: Service1, Service2, Service3, Service4, Service 5 and, Service 6.

Option

Use ▼ button to highlight the "Option" item, then press ► button to enter into the following menu.

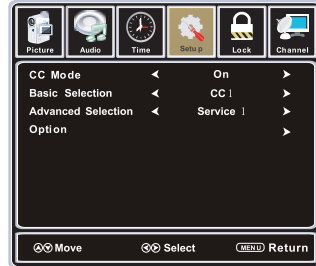

Use ▲ / ▼ buttons to highlight the desired item, and use ◀ / ▶ buttons to select.

DLC

Dynamic luminance control **On** or **Off**.

TV Location

Select Home Mode and Standard Mode.

Restore Default

Restores all settings to factory settings.



Lock Menu

Select TV source for example.

1. Press the MENU button on the remote control to display the Main menu, and use the ◀/▶ buttons to select Lock.
2. Use the ▼ button to highlight the "Enter Password" item, use the numeric keys to input a 4 digit password, then the screen will display a sub-menu. After making your selections, press MENU to exit.

NOTE: The factory password is 0000.

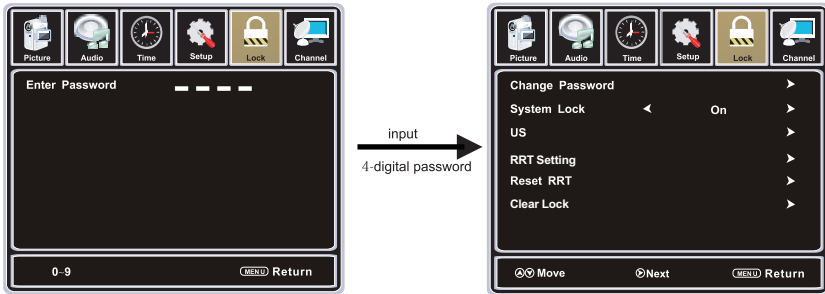

The Lock menu includes the following options :

Change Password

Use ▼ button to select the "Change Password" item, then press ► button to enter into the following menu. Input the new 4 digit password and repeat to confirm.

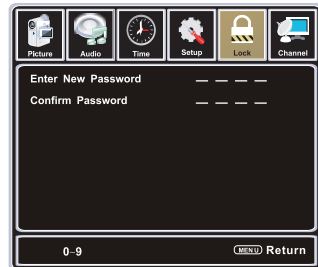

System Lock

Allows you to turn on or off the system lock. If you turn off the system lock, then the following items (US and Reset RRT) will be unavailable.

US

Use ▼ button to highlight the "US" item, then press ► button to enter into the following menu.

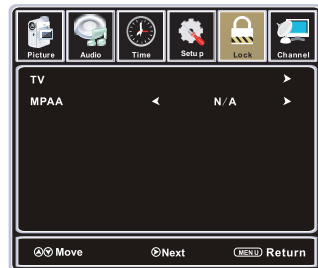

Lock Menu

(Continued)

TV

Use ▼ button to highlight the "TV" item, then press ► button to enter into the following menu.

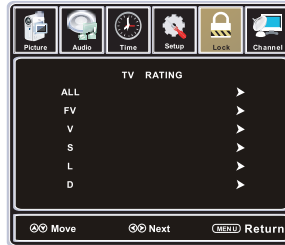

Use ▲/▼/◀/▶ buttons to select the desired rating and press OK button to block or unblock rating.

MPAA

The Movie rating (MPAA) is used for original movies rated by the Motion Picture Association of America (MPAA) as broadcasted on cable TV and not edited for television.

Use the ▲/▼ buttons to select N/A, G, PG, PG-13, R, NC-17 or X.

RATING	DESCRIPTION
N/A	No restriction
G	General Audiences. Movie is appropriate for all ages.
PG	Parental Guidance Suggested. May contain material not suited for younger viewers.
PG-13	Contains content that may not be appropriate for viewers under the age of 13.
R	Restricted. Contains adult content, no one under 17 admitted without parent.
NC-17	No one 17 and under admitted.
X	X is an older rating that is unified with NC-17 but may be encoded in the data of older movies.

RRT Setting

Rating Region Table setting.

Reset RRT

Allows you to reset the RRT setting.

Clear Lock

Clear lock of RRT.

Channel Menu

Select TV source.

1. Press the MENU button on the remote control to display the Main menu, and use the ◀/▶ buttons to select the Channel.
2. Use the ▲/▼ buttons to highlight an individual Channel option, use the ◀/▶ buttons to change the setting, and press the MENU button to exit.

The Channel menu includes the following options :

Air / Cable

Allows you to select the signal of Air or Cable.

Use ▼ button to highlight the “Auto Scan” item, then press ▶ button to enter into the following menu.

If you select “Air” as the input signal in the Antenna item, you can press ▶ button to search the channels automatically.

The receivable channels will be stored automatically.
When searching channels, press MENU to stop.

If you select “Cable” as the input signal in the Antenna item, this will allow you to select a Cable system among: AUTO, STD, IRC and HRC.

Use ▼ button to highlight the “Start to Scan”, then press ▶ button to search the channels automatically.

The receivable channels will be stored automatically.
When searching channels, press MENU to stop.

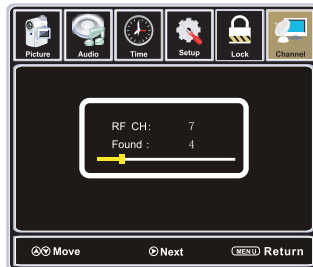
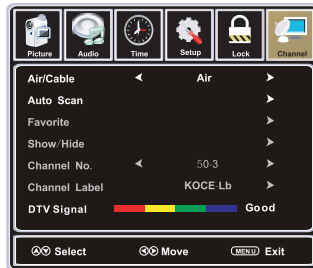

Channel Menu

(Continued)

Favorite

Allows you to add channels which you select as your favorites.

Use ▲ or ▼ button to highlight the "Favorite" item, then press ► button to enter into the following menu.

Use ▲ / ▼ button to highlight the desired item, then press the OK button to add or remove the highlighted channel as a favorite.

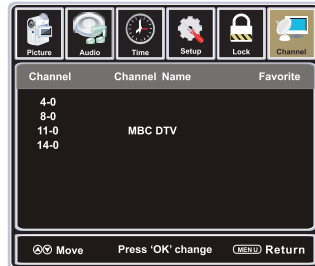

Show / Hide

Allows you to show or hide the channels.

Use ▲ or ▼ button to highlight the "Show / Hide" item, then press ► button to enter into the following menu.

Use ▲ / ▼ button to highlight the desired item, then press the OK button to show or hide the highlighted channel.

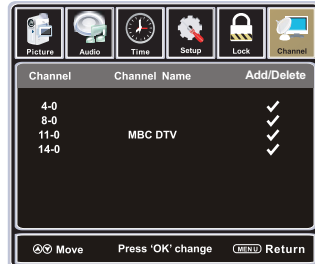

Channel No.

Display the number of the current channel.

Channel Label

Display the label of the current channel.

DTV Signal

Display the quality of the current DTV Signal.

Reception disturbances

Most types of television interference can be remedied by adjusting the height and position of the VHF/ UHF antenna. Outdoor antennas are recommended for best results. The most common types of television interference are shown below. If one of these symptoms appear when the TV is connected to a Cable TV system, the disturbance may be caused by the local Cable TV company broadcast.

IGNITION

Black spots or horizontal streaks may appear, the picture may flutter or drift. Usually caused by interference from automobile ignition systems, neon lamps or AC powered tools and appliances such as drills or hair dryers.



GHOSTS

Ghosts are caused by the television signal following two paths. One is the direct path and the other is reflected by tall buildings, hills or other large objects. Changing the direction or position of the antenna may improve the reception.



SNOW

If the TV is located far from the TV station, in a fringe reception area where the signal is weak, small dots may appear in the picture. If the signal is extremely weak, the installation of a larger external antenna may be necessary.



RADIO FREQUENCY INTERFERENCE (RFI)

Caused by two-way radios, this type of interference produces moving ripples or diagonal streaks in the picture. Some cases may cause a loss of contrast in the picture. Changing the direction and position of the antenna or installing an RFI filter may improve the picture.



PICTURE SIZE VARIATION

A slight picture size variation is normal when you adjust the CONTRAST or BRIGHTNESS settings.



CARE AND MAINTENANCE

To prevent fire or shock hazard, disconnect the TV from the power source before cleaning. The finish on the cabinet may be cleaned with mild soap and a soft, damp cloth and cared for as other furniture. Use caution when cleaning or wiping the plastic parts.

Troubleshooting

Use the following checklist for troubleshooting if you have problems with your LED-LCD TV. Consult your local dealer or service outlet if problems persist. Be sure all connections are properly made when using with other units.

SYMPTOMS	POSSIBLE SOLUTIONS
TV does not operate.	<ul style="list-style-type: none"> • Make sure the power cord is plugged in. • Try another AC outlet. • Power is off, check fuse or circuit breaker. • Unplug unit for an hour, then plug it back in.
Poor sound or no sound.	<ul style="list-style-type: none"> • Station or Cable TV experiencing problems, tune to another station. • Check sound adjustments (VOL +/- or MUTE). • Check for sources of possible interference.
Poor picture or no picture.	<ul style="list-style-type: none"> • Station or Cable TV experiencing problems, tune to another station. • Make sure channels are set into memory. • Check antenna or Cable TV connections, adjust antenna. • Check for sources of possible interference. • Check picture control adjustments.
Poor reception on some channels.	<ul style="list-style-type: none"> • Station or Cable TV experiencing problems, tune to another station. • Make sure channels are set into memory. • Station is weak, adjust antenna to receive desired station. • Check for sources of possible interference.
Poor color or no color.	<ul style="list-style-type: none"> • Station or Cable TV experiencing problems, tune to another station. • Make sure channels are set into memory. • Check picture control adjustments. • Check antenna or Cable TV connections, adjust antenna. • Check for sources of possible interference.
Picture wobbles or drifts.	<ul style="list-style-type: none"> • Station or Cable TV experiencing problems, tune to another station. • Make sure channels are set into memory. • Cable TV company is scrambling signal. • Adjust antenna.

SYMPTOMS	POSSIBLE SOLUTIONS
Digital broadcasting screen problem.	<ul style="list-style-type: none"> • Check digital signal strength.
No CATV reception.	<ul style="list-style-type: none"> • Check all Cable TV connections. • Set Air/Cable menu option to the Cable mode. • Station or Cable TV system problems, try another station.
Horizontal or diagonal bars on screen.	<ul style="list-style-type: none"> • Check antenna connections, adjust or re-direct antenna. • Check for sources of possible interference.
No reception above channel 13.	<ul style="list-style-type: none"> • Make sure Air/Cable option is in the appropriate mode. • If using antenna, check UHF antenna connections.
No Remote operation.	<ul style="list-style-type: none"> • Batteries are weak, dead or inserted incorrectly. • Remote is out of range, move closer to TV. • Make sure Remote is aimed at sensor. • Confirm there are no obstructions between the Remote and the TV. • Make sure the power cord is plugged in.
TV shuts off.	<ul style="list-style-type: none"> • Sleep Timer is set. • Power interrupted.
Closed Caption is not activated.	<ul style="list-style-type: none"> • TV station experiencing problems or program tuned is not closed captioned. Try another channel. • Check Cable TV connection or VHF/UHF antenna, reposition or rotate antenna. • Set closed caption decoder in the menu.
TV is not shown in your language.	<ul style="list-style-type: none"> • Select proper language in the menu options.

BLOCK NOISE / PICTURE FREEZE

Block noise or picture freeze may appear on the screen caused by weak signals, interference from automobile ignition systems, neon lamps or AC powered tools and appliances such as drills or hair dryers.



FOR CUSTOMER SERVICE, ADDITIONAL SET-UP AND OPERATING ASSISTANCE, OR TO ORDER ACCESSORIES PLEASE CALL:

1-800-289-0980

WHEN CALLING CUSTOMER SERVICE - PLEASE HAVE YOUR MODEL NUMBER READY

OR WRITE TO:
ORION SALES, INC.
 3471 N. UNION DR.
 OLNEY, ILLINOIS 62450

FOR INFORMATION ON OUR OTHER PRODUCTS, OR TO ORDER ACCESSORIES ONLINE OR FOR RECYCLING INFORMATION, PLEASE VISIT OUR WEBSITE AT

www.orionsalesinc.com

Specifications

SLED4650	
GENERAL	
Power supply:	AC 120V 60Hz
Power consumption:	Operation: 113 W Standby: 0.5 W
Weight:	19.5 kg (52.2 lbs)
Dimensions:	Width: 1107 mm (43.6 inches) Height: 753 mm (29.7 inches) Depth: 310 mm (12.2 inches)
Operating temperature:	0°C - 40°C
Operating humidity:	Less than 80% RH
Type:	1,168.1 mmV (46" class/45.99" diagonal)
Display method:	Transmission TFT color LED panel
Number of Pixels:	1920 (H) x 1080 (V)
Broadcasting system:	US system M ATSC standard (8VSB), QAM
Receiving channels:	VHF 2-13 UHF 14-69 CATV 14-36 (A)-(W) 37-59 (AA)-(WW) 60-85 (AAA)-(ZZZ) 86-94 (86)-(94) 95-99 (A-5)-(A-1) 100-135 (100)-(135) 01 (4A)
Tuner type:	Frequency synthesized
Inputs:	Video: (RCA) 1 V (p-p), 75 ohms Audio: (RCA) 8 dBm/50k ohms Component video: (Y) 1 V (p-p), 75 ohms (Pb)/(Pr) 0.7 V (p-p), 75 ohms HDMI: HDMI compliant (type A connector) HDCP compliant E-EDID compliant Suggested scan rates: 480p, 480i, 720p, 1080i, 1080p HDMI Audio: 2-channel PCM 32/44.1/48 kHz sampling frequency 16/20/24 bits per sample PC Monitor: Mini-Dsub 15pin x 1 Antenna: VHF/UHF In 75 ohms coaxial
Outputs:	Digital audio out: 0.5 V(p-p), 75 ohms terminated Audio: 0-600 mV rms / 1k ohm
Speakers:	8 ohms x 2
Audio output power:	6W + 6W
ACCESSORIES	Remote control Batteries AAA x 2 Stand Screws x 6 frame stand

Designs and specifications are subject to change without notice.



limited
WARRANTY

46" CLASS WIDE LED-LCD TV

ORION warrants this product to be free from manufacturing defects in material and workmanship under normal use and conditions for a period of 1 year from date of original purchase in the United States.

Should service be necessary under this warranty for any reason due to a manufacturing defect or malfunction during the first 12 months from date of original purchase, ORION will provide in-home repair service by an ORION authorized Independent Service Center at no charge. Also, if an original part fails due to manufacturing defect in material and workmanship within one year from date of original purchase we will replace the defective part, provided the defect or malfunction is verified along with dated proof of purchase.

There are ORION authorized Independent Service Centers located throughout the country. For the one nearest you, DIAL TOLL FREE: 1-800-289-0980 or visit our website at www.orionsalesinc.com. ORION will not be liable for damages incurred in shipment of the unit. If there are no ORION authorized Independent Service Centers in your area please call - 1-888-296-7466 for assistance.

Note: This warranty is void if the product is:

- (a) Damaged through negligence, misuse, abuse, or accident.
- (b) Used in a commercial application or rentals.
- (c) Modified or repaired by anyone other than an Independent Service Center authorized by ORION to effect warranty repairs to the class of product or by the ORION Factory Service Center.
- (d) Damaged because it is improperly connected to the equipment of other manufacturers.

This warranty does not cover:

- (a) Damage to equipment not properly connected to the product.
- (b) Costs incurred in the shipping of the product to an ORION authorized Independent Service Center or ORION Factory Service Center.
- (c) Damage or improper operation of unit caused by customer abuse, misuse, negligence, or failure to follow operating instructions provided with the product.
- (d) Ordinary adjustments to the product which can be performed by customer as outlined in the owner's manual.
- (e) Signal reception problems caused by external antenna or cable systems.

THIS WARRANTY IS NON TRANSFERABLE AND APPLIES ONLY TO THE ORIGINAL PURCHASER AND DOES NOT EXTEND TO SUBSEQUENT OWNERS OF THE PRODUCT. ANY APPLICABLE IMPLIED WARRANTIES, INCLUDING THE WARRANTY OF MERCHANTABILITY, ARE LIMITED IN DURATION TO A PERIOD OF THE EXPRESS WARRANTY AS PROVIDED HEREIN BEGINNING WITH THE DATE OF ORIGINAL PURCHASE AT RETAIL AND NO WARRANTIES, WHETHER EXPRESS OR IMPLIED SHALL APPLY TO THIS PRODUCT THEREAFTER. ORION MAKES NO WARRANTY AS TO THE FITNESS OF THE PRODUCT FOR ANY PARTICULAR PURPOSE AND USE.

UNDER NO CIRCUMSTANCES SHALL ORION BE LIABLE FOR ANY LOSS, DIRECT, INDIRECT, INCIDENTAL, SPECIAL, OR CONSEQUENTIAL DAMAGE ARISING OUT OF OR IN CONNECTION WITH THE USE OF THIS PRODUCT.

THIS WARRANTY IS VALID ONLY IN THE UNITED STATES OF AMERICA. THIS WARRANTY GIVES YOU SPECIFIC LEGAL RIGHTS, HOWEVER, YOU MAY HAVE OTHER RIGHTS WHICH MAY VARY FROM STATE TO STATE. SOME STATES DO NOT ALLOW LIMITATIONS ON IMPLIED WARRANTIES OR EXCLUSIONS OF CONSEQUENTIAL DAMAGES, THEREFORE THESE RESTRICTIONS MAY NOT APPLY TO YOU.

ORION AMERICA, INC.
3471 N. UNION DR.
OLNEY, ILLINOIS 62450